

# YAMAHA RX-460

*Natural Sound Stereo Receiver*

*55W + 55W (8Ω) RMS Output Power, 0.04% THD, 20 – 20,000 Hz*

*High Dynamic Power, Low Impedance Drive Capability*

*Continuously Variable Loudness Control*

*Source Direct Switch to Reproduce the Purest Source Sound*

*40-Station Random Preset Tuning*

*IF Count Direct PLL Synthesizer Tuning System*

*Remote Control Capability*

Thank you for selecting this YAMAHA stereo receiver.



## OWNER'S MANUAL

### CONTENTS

Safety Instructions .....	2
Supplied Accessories .....	3
Connections .....	4
Operations .....	7
Tuning Operations .....	10
Remote Control Transmitter ...	12
Troubleshooting .....	14
Specifications .....	15

#### IMPORTANT!

Please record the serial number of this unit in the space below.

Model:  
Serial No.:

The serial number is located on the rear of the unit.  
Retain this Owner's Manual in a safe place for future reference.

#### WARNING

TO REDUCE THE RISK OF FIRE OR ELECTRIC SHOCK, DO NOT EXPOSE THIS UNIT TO RAIN OR MOISTURE.

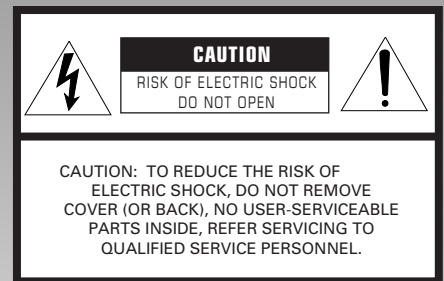

#### • Explanation of Graphical Symbols



The lightning flash with arrowhead symbol, within an equilateral triangle, is intended to alert you to the presence of uninsulated "dangerous voltage" within the product's enclosure that may be of sufficient magnitude to constitute a risk of electric shock to persons.



The exclamation point within an equilateral triangle is intended to alert you to the presence of important operating and maintenance (servicing) instructions in the literature accompanying the appliance.

# SAFETY INSTRUCTIONS

- 1 Read Instructions – All the safety and operating instructions should be read before the unit is operated.
- 2 Retain Instructions – The safety and operating instructions should be retained for future reference.
- 3 Heed Warnings – All warnings on the unit and in the operating instructions should be adhered to.
- 4 Follow Instructions – All operating and other instructions should be followed.
- 5 Water and Moisture – The unit should not be used near water – for example, near a bathtub, washbowl, kitchen sink, laundry tub, in a wet basement, or near a swimming pool, etc.
- 6 Carts and Stands – The unit should be used only with a cart or stand that is recommended by the manufacturer.
- 6A A unit and cart combination should be moved with care. Quick stops, excessive force, and uneven surfaces may cause the unit and cart combination to overturn. 
- 7 Wall or Ceiling Mounting – The unit should be mounted to a wall or ceiling only as recommended by the manufacturer.
- 8 Ventilation – The unit should be situated so that its location or position does not interfere with its proper ventilation. For example, the unit should not be situated on a bed, sofa, rug, or similar surface, that may block the ventilation openings; or placed in a built-in installation, such as a bookcase or cabinet that may impede the flow of air through the ventilation openings.
- 9 Heat – The unit should be situated away from heat sources such as radiators, stoves, or other appliances that produce heat.
- 10 Power Sources – The unit should be connected to a power supply only of the type described in the operating instructions or as marked on the unit.
- 11 Power-Cord Protection – Power-supply cords should be routed so that they are not likely to be walked on or pinched by items placed upon or against them, paying particular attention to cords at plugs, convenience receptacles, and the point where they exit from the unit.
- 12 Cleaning – The unit should be cleaned only as recommended by the manufacturer.
- 13 Nonuse Periods – The power cord of the unit should be unplugged from the outlet when left unused for a long period of time.
- 14 Object and Liquid Entry – Care should be taken so that objects do not fall into and liquids are not spilled into the inside of the unit.
- 15 Damage Requiring Service – The unit should be serviced by qualified service personnel when:
  - A. The power-supply cord or the plug has been damaged; or
  - B. Objects have fallen, or liquid has been spilled into the unit; or
  - C. The unit has been exposed to rain; or
  - D. The unit does not appear to operate normally or exhibits a marked change in performance; or
  - E. The unit has been dropped, or the cabinet damaged.
- 16 Servicing – The user should not attempt to service the unit beyond those means described in the operating instructions. All other servicing should be referred to qualified service personnel.
- 17 Power Lines – An outdoor antenna should be located away from power lines.

- 18 Grounding or Polarization – Precautions should be taken so that the grounding or polarization is not defeated.
- 19 Outdoor Antenna Grounding – If an outside antenna is connected to this unit, be sure the antenna system is grounded so as to provide some protection against voltage surges and built-up static charges. Article 810 of the National Electrical Code, ANSI/NFPA 70, provides information with regard to proper grounding of the mast and supporting structure, grounding of the lead-in wire to an antenna discharge unit, size of grounding conductors, location of antenna discharge unit, connection to grounding electrodes, and requirements for the grounding electrode.

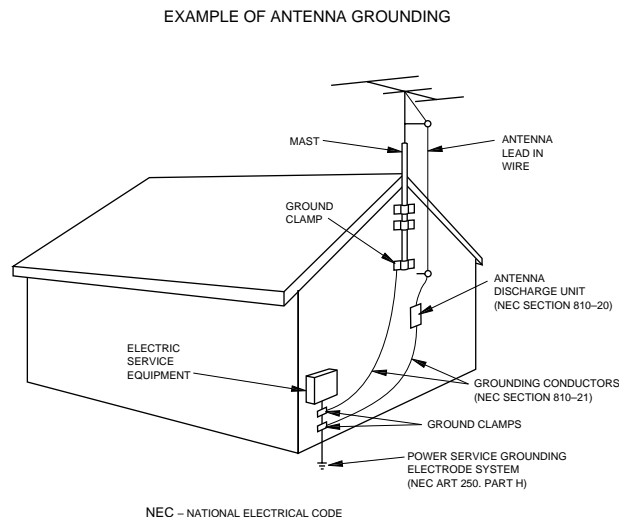

## Note to CATV system installer:

This reminder is provided to call the CATV system installer's attention to Article 820-40 of the NEC that provides guidelines for proper grounding and, in particular, specifies that the cable ground shall be connected to the grounding system of the building, as close to the point of cable entry as practical.

## CAUTION: READ THIS BEFORE OPERATING YOUR UNIT

- 1 To ensure the finest performance, please read this manual carefully. Keep it in a safe place for future reference.
- 2 Install your unit in a cool, dry, clean place – away from windows, heat sources, and too much vibration, dust, moisture or cold. Avoid sources of hum (transformers, motors). To prevent fire or electrical shock, do not expose to rain and water.
- 3 Do not operate the unit upside-down. It may overheat, possibly causing damage.
- 4 Never open the cabinet. If a foreign object drops into the set, contact your dealer.
- 5 Do not use force on switches, knobs or cords. When moving the set, first turn the unit off. Then gently disconnect the power plug and the cords connecting to other equipment. Never pull the cord itself.
- 6 Do not attempt to clean the unit with chemical solvents; this might damage the finish. Use a clean, dry cloth.

- 7 Always set the volume control to “- ∞” before starting the audio source play: increase the volume gradually to an appropriate level after the play is started.
- 8 To prevent lightning damage, pull out the power cord and remove the antenna cable during an electrical storm.
- 9 Be sure to read the “Troubleshooting” section on common operating errors before concluding that your unit is faulty.
- 10 Do not connect audio equipment to the AC outlets on the rear panel if that equipment requires more power than the outlets are rated to provide.

**FCC INFORMATION**

**1. IMPORTANT NOTICE : DO NOT MODIFY THIS UNIT!**

This product, when installed as indicated in the instructions contained in this manual, meets FCC requirements. Modifications not expressly approved by Yamaha may void your authority, granted by the FCC, to use the product.

**2. IMPORTANT :** When connecting this product to accessories and/or another product use only high quality shielded cables. Cable/s supplied with this product MUST be used. Follow all installation instructions. Failure to follow instructions could void your FCC authorization to use this product in the USA.

**3. NOTE :** This product has been tested and found to comply with the requirements listed in FCC Regulations, Part 15 for Class “B” digital devices. Compliance with these requirements provides a reasonable level of assurance that your use of this product in a residential environment will not result in harmful interference with other electronic devices.

This equipment generates/uses radio frequencies and, if not installed and used according to the instructions found in the users manual, may cause interference harmful to the operation of other electronic devices.

Compliance with FCC regulations does not guarantee that interference will not occur in all installations. If this product is found to be the source of interference, which can be determined by turning the unit “OFF” and “ON”, please try to eliminate the problem by using one of the following measures:

Relocate either this product or the device that is being affected by the interference.

Utilize power outlets that are on different branch (circuit breaker or fuse) circuits or install AC line filter/s.

In the case of radio or TV interference, relocate/reorient the antenna. If the antenna lead-in is 300 ohm ribbon lead, change the lead-in to coaxial type cable.

If these corrective measures do not produce satisfactory results, please contact the local retailer authorized to distribute this type of product. If you can not locate the appropriate retailer, please contact Yamaha Electronics Corp., U.S.A. 6660 Orangethorpe Ave, Buena Park, CA 90620.

The above statements apply ONLY to those products distributed by Yamaha Corporation of America or its subsidiaries.

**We Want You Listening For A Lifetime**

YAMAHA and the Electronic Industries Association’s Consumer Electronics Group want you to get the most out of your equipment by playing it at a safe level. One that lets the sound come through loud and clear without annoying blaring or distortion – and, most importantly, without affecting your sensitive hearing. Since hearing damage from loud sounds is

often undetectable until it is too late, YAMAHA and the Electronic Industries Association’s Consumer Electronics Group recommend you to avoid prolonged exposure from excessive volume levels.



**SUPPLIED ACCESSORIES**

After unpacking, check that the following parts are contained.

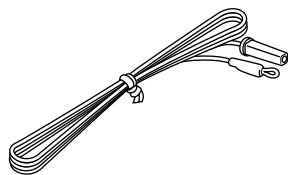

Indoor FM Antenna

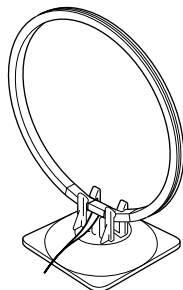

AM Loop Antenna

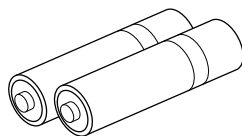

Batteries (size AA, R6, UM-3)

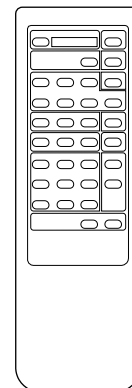

Remote Control Transmitter

# CONNECTIONS

Before attempting to make any connections to or from this unit, be sure to first switch OFF the power to this unit and to any other components to which connections are being made.

## AUDIO CONNECTIONS

When making connections between this unit and other components, be sure all connections are made correctly, that is to say L (left) to L, R (right) to R, "+" to "+" and "-" to "-". Also, refer to the owner's manual for each component to be connected to this unit.

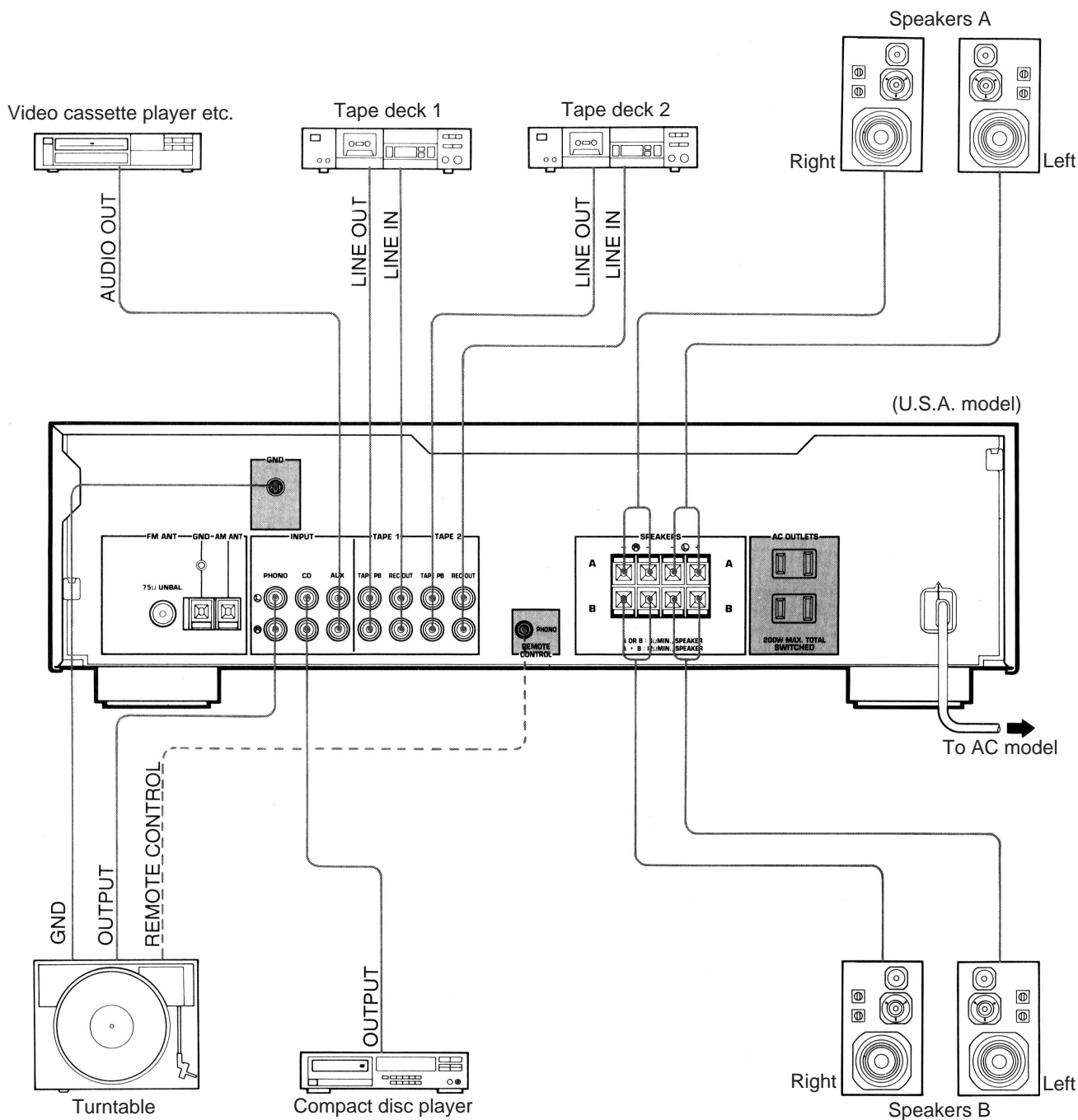

\*  : Refer to "ABOUT THE ACCESSORY TERMINALS" on page 5.

## CONNECTING SPEAKERS

Connect the **SPEAKERS** terminals to your speakers with wire of the proper gauge, cut to be as short as possible. If the connections are faulty, no sound will be heard from the speakers. Make sure that the polarity of the speaker wires is correct, that is, + and – markings are observed. If these wires are reversed, the sound will be unnatural and will lack bass.

**Do not let the bare speaker wires touch each other and do not let them touch the metal parts of this unit as this could damage this unit and/or speakers.**

- One or two speaker systems can be connected to this unit. If you connect only one speaker system, connect it to either the **SPEAKERS A** or **B** terminals.
- Use speakers with the specified impedance shown on the rear of this unit.

### How to Connect:

Red: positive (+)  
Black: negative (-)

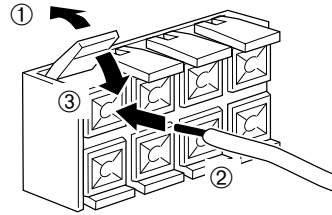

- ① Press up the tab.
- ② Insert the bare wire. [Remove approx. 5mm (1/4") insulation from the speaker wires.]
- ③ Press down the tab and secure the wire.

---

## ABOUT THE ACCESSORY TERMINALS

### AC OUTLETS

(U.S.A., Canada Europe and General models)

.....2 SWITCHED OUTLETS  
(Australia and U.K. models)

.....1 SWITCHED OUTLET  
Use these to connect the power cords from your components to this unit.

The power to the **SWITCHED** outlets is controlled by this unit's **POWER** switch or the provided remote control transmitter's **POWER** key. These outlets will supply power to any component whenever this unit is turned on.

The maximum power (total power consumption of components) that can be connected to the **SWITCHED AC OUTLETS** is 100 watts (200 watts for U.S.A. and General models).

### REMOTE CONTROL (PHONO) connector

If you have a YAMAHA turntable with the *RS* mark, connect it to this connector by using the cable provided with the turntable. This connection allows you to control the turntable from the provided remote control transmitter.

### GND terminal (For turntable use)

Connecting the ground wire of the turntable to this terminal will minimize hum, but in some cases better results may be obtained with the ground wire disconnected.

# ANTENNA CONNECTIONS

- Each antenna should be connected to the designated terminals correctly, referring to the following figure.
- Both AM and FM indoor antennas are included with this unit. In general, these antennas will probably provide sufficient signal strength. Nevertheless, a properly installed outdoor antenna will give clearer reception than an indoor one. If you experience poor reception quality, an outdoor antenna may result in improvement.

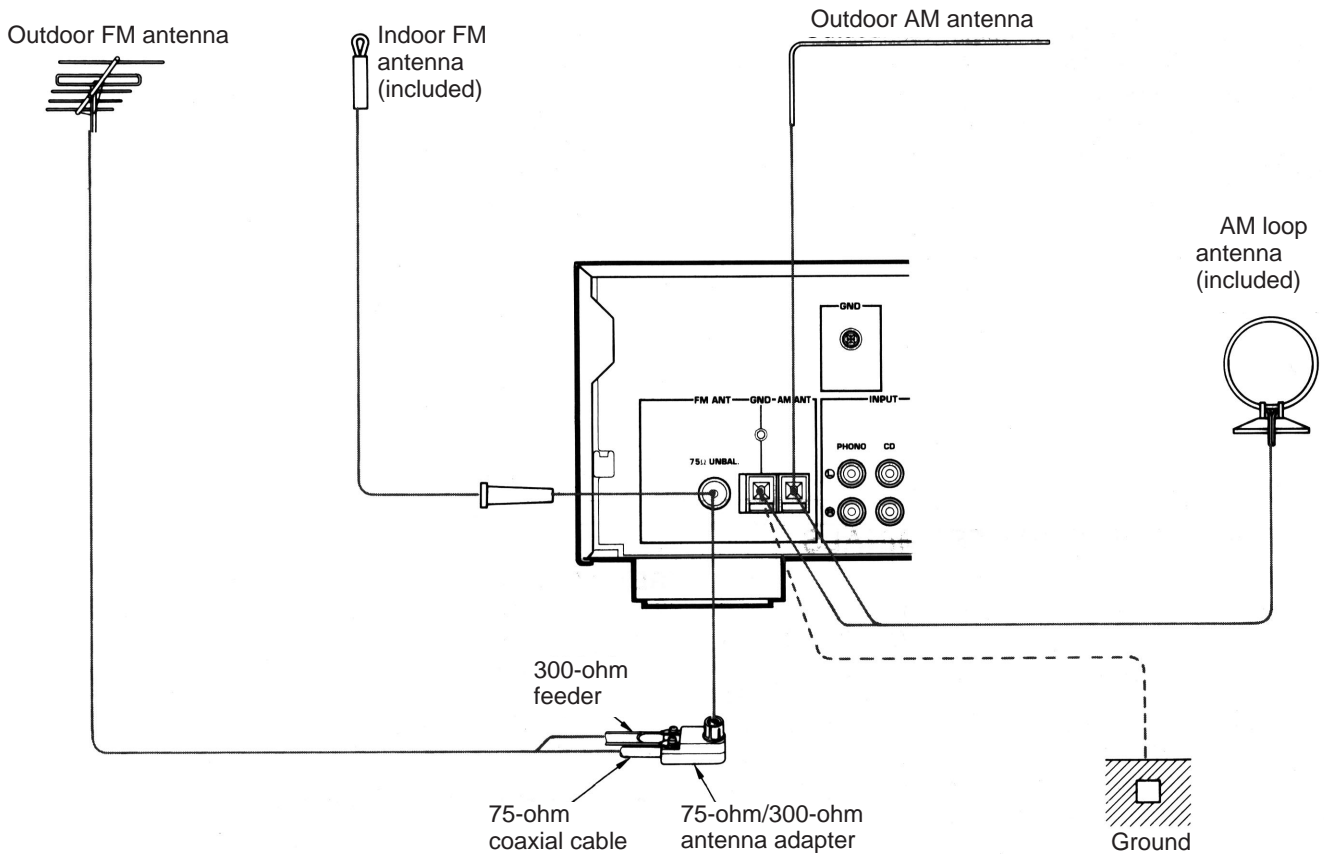

## Connecting the AM loop antenna

1

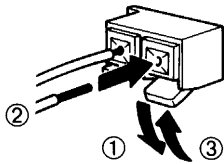

2

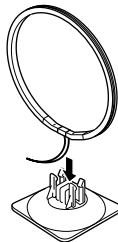

3

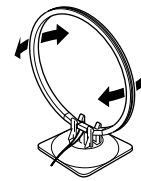

Orient so that the best reception is obtained.

\* The antenna may be hung on a wall.

\* The AM loop antenna should be kept being connected, even if an outdoor AM antenna is connected to this unit.

## GND terminal

For maximum safety and minimum interference, connect the **GND** terminal to a good earth ground. A good earth ground is a metal stake driven into moist earth.

## Notes

- When connecting the indoor FM antenna, make sure that the grooved part of the connector hole is facing downward.
- If you need an outdoor FM antenna to improve FM reception quality, either 300-ohm feeder or coaxial cable may be used. In locations troubled by electrical interference, coaxial cable is preferable.

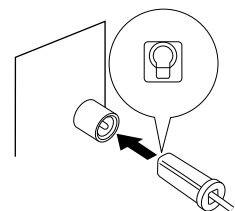



# OPERATIONS

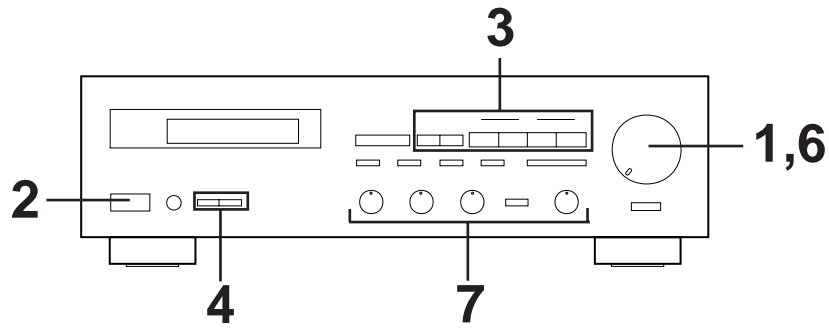

## TO PLAY A SOURCE

**1** **VOLUME**

Set to the "∞" position.

**2** **POWER**

**3** Select a desired input source.

- \* The name of the selected input source will appear in the display.
- \* Note that pressing on each input selector selects the source which is connected to the corresponding input terminals on the rear panel.

**4** Select the speakers to be used.

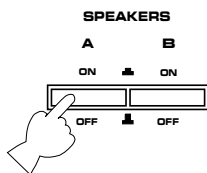

- \* If you use two speaker systems, press both the A and B switches.

**5** Play the source. (For detailed information on the tuning operations, refer to the page 10.)

**6** **VOLUME**

Adjust to the desired output level.

**7** If desired, adjust the **BASS, TREBLE, BALANCE** and **LOUDNESS** controls, etc. (Refer to page 9.)

### Note

In the step 3, if two or more program sources are selected at the same time (by using input selectors), be sure to remember the priority order of the input sources.

**Priority order of sources:** 1) **TAPE 1**, 2) **TAPE 2**, 3) **AUX, TUNER, CD** or **PHONO**.

- If you select **AUX, TUNER, CD** or **PHONO**, be sure that **TAPE 1** and/or **TAPE 2** are not being selected.
- If you select **TAPE 1** and **TAPE 2** at the same time, the result will be the sound from the tape deck 1.
- If you select both **AUX** and **TAPE 1** at the same time, the result will be the sound from the tape deck 1.

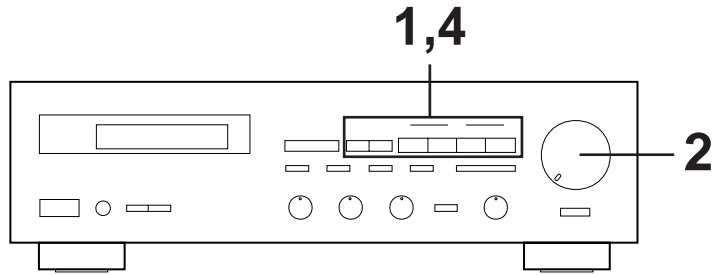

## TO RECORD A SOURCE TO TAPE

**1** Select the source to be recorded.

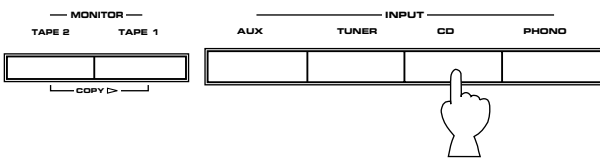

- \* To dub from tape to tape, refer to the “Notes” shown at right.
- \* When selecting **AUX**, **TUNER**, **CD** or **PHONO**, be sure that **TAPE 1** and/or **TAPE 2** are not also selected.

**2** Play the source and then turn the **VOLUME** control up to confirm the input source. (For detailed information on the tuning operations, refer to the page 10.)

**3** Set the tape deck in the recording mode.

**4** To monitor the audio signals being recorded, press the input selector button for the tape deck being used to make the recording.

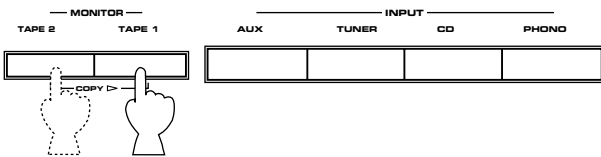

### Notes

- **VOLUME**, **BASS**, **TREBLE**, **BALANCE** and **LOUDNESS** control settings have no effect on the material being recorded.
- To dub from tape to tape, only the following one way of dubbing can be performed.

SOURCE	RECORDER
Tape deck connected to the TAPE 2 terminals.	→ Tape deck connected to the TAPE 1 terminals.



## Adjusting the BALANCE control

Adjust the balance of the output volume to the left and right speakers to compensate for sound imbalance caused from speaker location or listening room conditions.

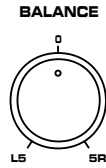

## Selecting the SPEAKER system

Because one or two speaker systems can be connected to this unit, the **SPEAKERS** switches allow you to select speaker system **A** or **B**, or both at once.

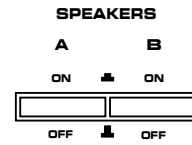

## Adjusting the BASS and TREBLE controls

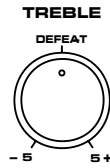
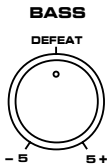

**BASS** : Turn this clockwise to increase (or counter-clockwise to decrease) the low frequency response.

**TREBLE** : Turn this clockwise to increase (or counter-clockwise to decrease) the high frequency response.

## Adjusting the continuously variable LOUDNESS control

This control provides compensation for the human ears' loss of sensitivity to high and low-frequency ranges at low volume. This control is adjustable to retain full tonal range at any volume level.

1

**LOUDNESS**

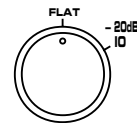

Set to the "FLAT" position.

2

**VOLUME**

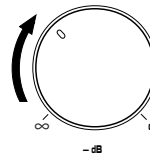

Set to the loudest listening level that you would listen to.

3

**LOUDNESS**

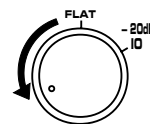

Turn so that the desired volume can be achieved.

## Using the SOURCE DIRECT switch

You can enjoy the purest possible sound from your audio sources by setting this switch **ON**. By doing so, the audio signal bypasses the **BASS**, **TREBLE**, **BALANCE** and **LOUDNESS** controls, eliminating any alterations to the audio signal.

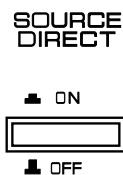

## When you listen with headphones

Connect the headphones to the **PHONES** jack. When listening with headphones privately, set both the **SPEAKERS A** and **B** switches to the **OFF** position.

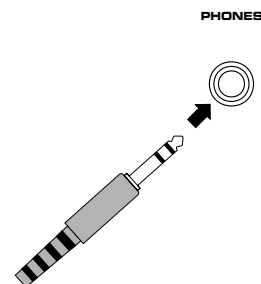

# TUNING OPERATIONS

Normally, if station signals are strong and there is no interference, quick automatic-search tuning (AUTOMATIC TUNING) is possible. However, if signals of the station you want to select are weak, you must tune to it manually (MANUAL TUNING).

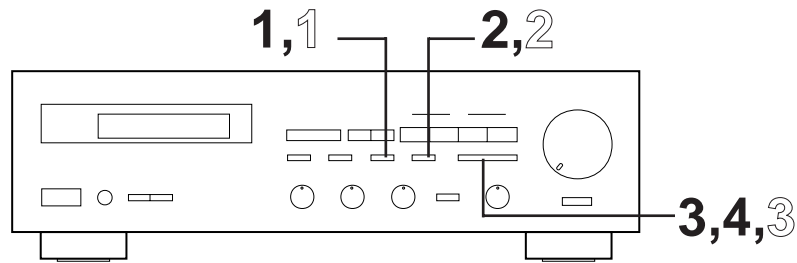

## AUTOMATIC TUNING

**1** Select the reception band (FM or AM) while watching the display.

FM/AM → — AM — or — FM —

**2** **TUNING MODE AUTO/MAN/1 MONO** → **00 MHz** STEREO 0 20 40 60 100 **AUTO TUNING**

**3** **DOWN TUNING UP**

To tune to a higher frequency, press the right side once.  
To tune to a lower frequency, press the left side once.

**4** If the station where tuning search stopped is not the desired one, follow step 3 again.

**DOWN TUNING UP**

\* If the tuning search does not stop at the desired station (because the signals of the station are weak), change to the MANUAL TUNING method.

## MANUAL TUNING

**1** Select the reception band (FM or AM) while watching the display.

FM/AM → — AM — or — FM —

**2** **TUNING MODE AUTO/MAN/1 MONO** → "AUTO TUNING" goes off.

**3** Tune to a desired station manually.

**DOWN TUNING UP**

\* To continue tuning search, press and hold the button.

### Note

If you tune to an FM station manually, it is received in monaural mode only to increase the signal quality.

## Display information

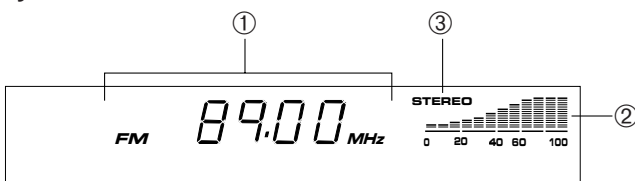

- ① Displays the band and frequency of the received station.
- ② Indicates the signal level of the received station.
- ③ Illuminates when an FM stereo broadcast with sufficient signal strength is received.

# PRESET TUNING

This unit can store station frequencies selected by tuning operation. With this function, you can recall any desired station by only selecting the preset station number where it is stored. Up to 40 stations (8 stations per page) can be stored.

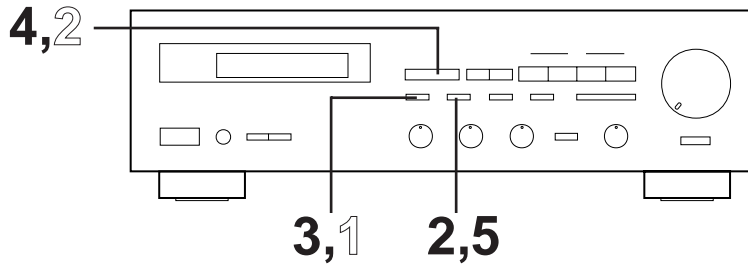

## TO PROGRAM STATIONS

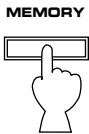
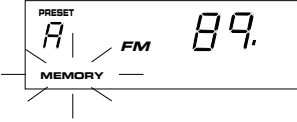
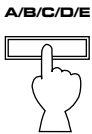
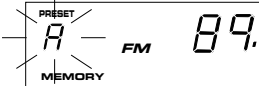
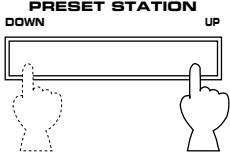
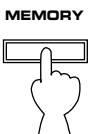
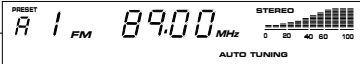
- 1** Tune to a desired station.  
(Refer to the previous page for tuning procedures.)
- 2**  →   
Flashes on and off for about 5 seconds.
- 3** Select a desired page (A – E) of preset stations while watching the display.  
 → 
- 4** Select a preset station number while watching the display before “MEMORY” goes off from the display.  

- 5**  →   
Shows the displayd station has been programmed to A1.

\* In the same way, program other stations to A2, A3 ... A8.  
\* You can program more stations on other pages in the same way by selecting other pages in step 2.

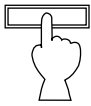
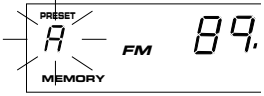
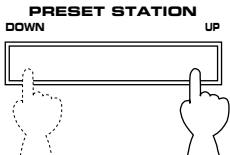
## TO RECALL A PRESET STATION

- 1** Select the page where the preset station is stored.  
 → 
- 2**   
Select the preset station number.

### Notes

- A new setting can be programmed in place of the former one.
- For presets, the setting of the reception mode (stereo or monaural) is stored along with the station frequency.

### Memory back-up

The memory back-up circuit prevents the programmed data from being lost even if the **POWER** switch is set off or the power plug is disconnected from the AC outlet or the power is cut due to temporary power failure. If, however, the power is cut for more than one week, the memory may be erased. If so, it can be re-programmed by simply following the PRESET TUNING steps.

# REMOTE CONTROL TRANSMITTER

The remote control transmitter provided with this unit is designed to control all the most commonly used functions of the unit. If the CD player, turntable, equalizer, and tape deck connected to this unit are YAMAHA components designed for remote control compatibility (components with an *RS* mark), then this remote control transmitter will also control various functions of each component. Please consult YAMAHA dealer for information on which components are compatible with the remote control transmitter.

## KEY FUNCTIONS

### For Control of This Unit

Turns the power on/off.

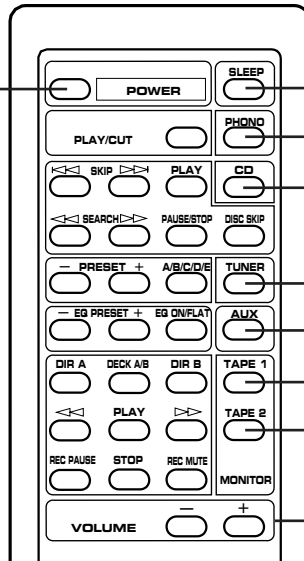

The power to the receiver is automatically turned off one hour after this key is pressed (so that "SLEEP" illuminates in the display).

Selects input source.

Turns the volume level up/down.

### For Other Component Control

Identify the remote control transmitter keys with your component's keys. If these keys are identical, their function will be the same. On each key function, refer to the corresponding instruction on your component's manual.

Starts/stops record play on turntable.

Controls tuner

+ : Selects higher preset station number.

- : Selects lower preset station number.

**A/B/C/D/E**: Selects the page (A - E) of preset stations.

Controls equalizer.

\* + and - keys select any preset equalizer curve whenever they are pressed.

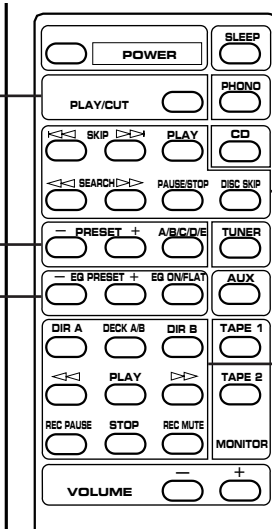

Controls compact disc player.

\* **DISC SKIP** is applicable only to compact disc auto changer.

Controls tape deck.

\* **DIR A, B** and **DECK A/B** are applicable only to double cassette tape deck.

\* For a single cassette deck with automatic reverse function, pressing **DIR A** will reverse the direction of tape running.

### STANDBY mode (Europe model only)

While the power is on, pressing the **POWER** key on the remote control transmitter switches the unit to the **STANDBY** mode. (In this mode, the indicator is half illuminated.)

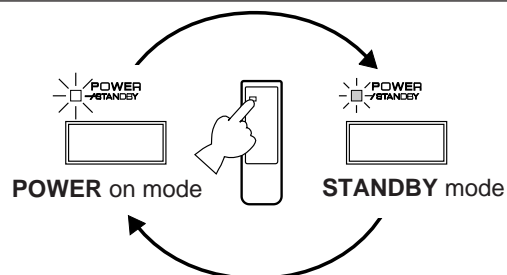

# NOTES ABOUT THE REMOTE CONTROL TRANSMITTER

## Battery installation

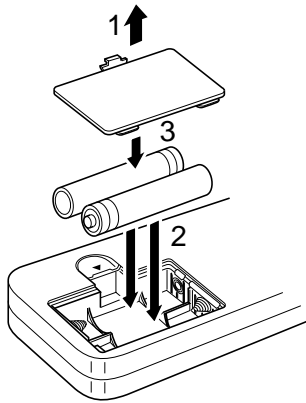

## Battery replacement

If you find that the remote control transmitter must be used closer to the main unit, the batteries are weak. Replace both batteries with new ones.

### Notes

- Use only AA, R6, UM-3 batteries for replacement.
- Be sure the polarities are correct. (See the illustration inside the battery compartment.)
- Remove the batteries if the remote control transmitter will not be used for an extended period of time.
- If batteries leak, dispose of them immediately. Avoid touching the leaked material or letting it come in contact with clothing, etc. Clean the battery compartment thoroughly before installing new batteries.

## Remote control transmitter operation range

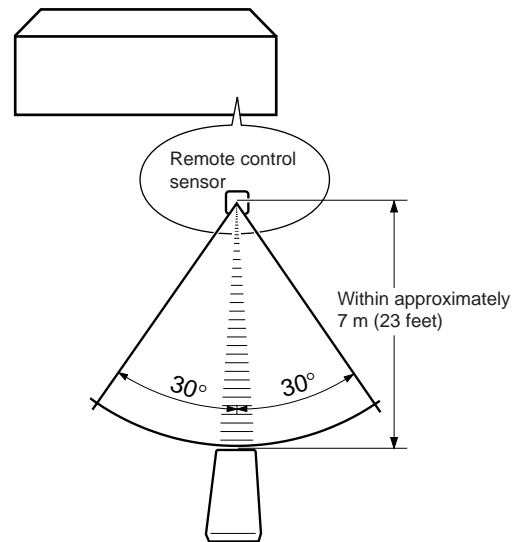

### Notes

- There should be no large obstacles between the remote control transmitter and the main unit.
- If the remote control sensor is directly illuminated by strong lighting (especially an inverter type of fluorescent lamp etc.), it might cause the remote control transmitter not to work correctly. In this case, reposition the main unit to avoid direct lighting.

# TROUBLESHOOTING

If the unit fails to operate normally, check the following points to determine whether the fault can be corrected by the simple measures suggested. If it cannot be corrected, or if the fault is not listed in the SYMPTOM column, disconnect the power cord and contact your authorized YAMAHA dealer or service center for help.

	SYMPTOM	CAUSE	REMEDY
Amplifier	The unit fails to turn on when the POWER switch is pressed.	Power cord is not plugged in or is not completely inserted.	Firmly plug in the power cord.
	No sound.	Incorrect output cord connections.	Connect the cords properly. If the problem persists, the cords may be defective.
		Appropriate input selector is not pressed.	Press the appropriate input selector corresponding to the input source.
	The sound suddenly goes off.	The protection circuit has activated because of short circuit etc.	Turning the unit off and then on will reset the protection circuit.
	Only one side speaker outputs the sound.	Incorrect setting of the BALANCE control	Adjust it to the appropriate position.
		Incorrect cord connection.	Connect cord properly. If the problem persists, the cables may be defective.
	Sound "hums".	Incorrect cord connections.	Firmly connect the audio plugs. If the problem persists, the cord may be defective.
No connection from the turntable to the GND terminal.		Make the GND connection between the turntable and this unit.	
The volume level is low while playing a record.	The record is being played on a turntable with an MC cartridge.	The player should be connected to the receiver through the MC head amplifier.	
FM	FM stereo reception is noisy.	Because of the characteristics of FM stereo broadcasts, this is limited to cases where the transmitter is too far or the antenna input is poor.	Check the antenna connections. Try using a multiple element FM antenna.
	There is distortion and clear reception cannot be obtained even with a good FM antenna.	There is multipath interference.	Adjust antenna placement to eliminate multipath interference.
	A desired station cannot be tuned in with Auto tuning.	The station is too weak.	Use Manual tuning mode. Use high quality directional FM antenna.
AM	A desired station cannot be tuned in with Auto tuning.	Weak signal or loose antenna connections.	Use Manual tuning mode.
			Tighten the AM loop antenna connections and rotate it for best reception.
	There are continuous crackling and hissing noises.	Noises will result from lightning, fluorescent lamps, motors, thermostats and other electrical equipment.	Use an outdoor antenna and a ground wire. This will help somewhat but it is difficult to eliminate all noise.
	There are buzzing and whining noises (especially in the evening).	A television set is being used nearby.	Move the television away.
Remote control transmitter	The remote control transmitter does not work.	Direct sunlight or lighting (of an inverter type of fluorescent lamp etc.) is striking the remote control sensor of the main unit.	Change position of the main unit.
	The distance or range within which the remote control transmitter can be used decreases.	The batteries of this remote control transmitter are too weak.	Replace the batteries with new ones.
Others	The sound is degraded when monitoring is performed by using the headphones connected to the compact disc player or cassette deck which are connected with this unit.	Power cord of this unit is not plugged.	Plug in the power cord.

# SPECIFICATIONS

## AUDIO SECTION

Minimum RMS Output Power per Channel  
 8 ohms, 20 Hz to 20 kHz, 0.04% THD  
 .....55W+55W  
 6 ohms, 20 Hz to 20 kHz, 0.06% THD  
 [U.S.A., Canada and General models]  
 .....60W+60W

Dynamic Power per Channel  
 (by IHF Dynamic Headroom measuring  
 method)  
 [U.S.A., Canada and General models]  
 8/6/4/2 ohms .....85/100/120/130W  
 [Australia, Europe and U.K. models]  
 8/6/4/2 ohms .....90/105/125/140W

DIN Standard Output Power per Channel  
 4 ohms, 1 kHz, 0.7% THD  
 [Europe model only] .....70W

IEC Power  
 8 ohms, 1 kHz, 0.04% THD  
 [Europe model only] .....77W

Power Band Width  
 8 ohms, 20W, 0.1% THD .....10 Hz to 40 kHz

Damping Factor  
 8ohms, 1 kHz .....50

Input Sensitivity/Impedance  
 PHONO MM .....2.5 mV/47 k-ohms  
 CD/TAPE/AUX .....150 mV/50 k-ohms

Maximum Input Signal (1 kHz, 0.01% THD)  
 PHONO MM .....80 mV

Output Level/Impedance  
 REC OUT .....150 mV/550 ohms

Headphone Jack Rated Output/Impedance  
 8 ohms, 1 kHz, 0.04% THD  
 Output Level .....0.4V  
 Impedance .....390 ohms

Frequency Response (20 Hz to 20 kHz)  
 CD/TAPE/AUX .....0±0.5 dB

RIAA Equalization Deviation  
 PHONO MM .....0±0.5 dB

Total Harmonic Distortion (20 Hz to 20 kHz)  
 PHONO MM to REC OUT (3V) .....0.01%  
 CD/TAPE/AUX to SP OUT (27.5W/8 ohms)  
 .....0.02%

Signal-to-Noise Ratio (IHF-A Network)  
 PHONO MM (5 mV Input Shorted) .....82 dB  
 CD/TAPE/AUX (Input Shorted) .....103 dB

Residual Noise (IHF-A Network) .....140 µV

Channel Separation (Vol. -30 dB)  
 PHONO MM (Input Shorted 1 kHz)  
 .....55 dB  
 CD/TAPE/AUX  
 (Input 5.1 k-ohms Terminated 1 kHz)  
 .....55 dB

Tone Control Characteristics  
 BASS: Boost/cut .....±10 dB (50 Hz)  
 TREBLE: Boost/cut .....±10 dB (20 kHz)

Continuous Loudness Control  
 .....-20 dB (1 kHz)  
 (Level related equalization)

## FM SECTION

Tuning Range  
 [U.S.A. and Canada models]  
 .....87.5 to 107.9 MHz  
 [Australia, Europe, U.K. and General  
 models] .....87.5 to 108.0 MHz

50 dB Quieting Sensitivity (IHF, 75 ohms)  
 [Except Europe model]  
 Mono .....1.55 µV (15.1 dBf)  
 Stereo .....21 µV (37.7 dBf)

Usable Sensitivity (75 ohms)  
 (30 dB S/N Quieting, 1 kHz, 100% mod.)  
 [Except Europe model]  
 .....0.8 µV (9.3 dBf)

DIN, Mono (S/N 26 dB) [Europe model]  
 .....0.9 µV

DIN, Stereo (S/N 46 dB) [Europe model]  
 .....24 µV

Image Response Ratio  
 [Except Europe model] .....45 dB  
 [Europe model] .....80 dB

IF Response Ratio .....80 dB

Spurious Response Ratio .....70 dB

AM Suppression Ratio .....55 dB

Capture Ratio .....1.5 dB

Alternate Channel Selectivity  
 [Except Europe model] .....85 dB

Selectivity (two signals, 40 kHz Dev.)  
 [Europe model] .....70 dB

Signal-to-Noise Ratio  
 (IHF) Mono/Stereo  
 [Except Europe model] .....81 dB/76 dB  
 (DIN-Weighted, 40 kHz Dev.) Mono/Stereo  
 [Europe model] .....75 dB/70 dB

Harmonic Distortion  
 Mono/Stereo (1 kHz)  
 [Except Europe model] .....0.1/0.2%  
 Stereo (40 kHz Dev.)  
 [Europe model] .....0.2%

Stereo Separation (1 kHz) .....50 dB

Frequency Response  
 30 Hz to 13 kHz .....0 ±0.5 dB  
 20 Hz to 15 kHz .....0 ±1.5 dB

## AM SECTION

Tuning Range  
 [U.S.A., Canada and General models]  
 .....530 to 1,710 kHz  
 [Australia, U.K. and Europe models]  
 .....531 to 1,611 kHz

Usable Sensitivity .....100 µV/m

Selectivity .....32 dB

Signal-to-Noise Ratio .....50 dB

Image Response Ratio .....40 dB

Spurious Response Ratio .....50 dB

Harmonic Distortion .....0.3%

## AUDIO SECTION

Output Level/Impedance  
 FM (100% mod., 1 kHz)  
 [Except Europe model]  
 .....500 mV/3.2 k-ohms  
 [Europe model (40 kHz Dev.)]  
 .....400 mV/3.2 k-ohms

AM (30% mod., 400 Hz)  
 [Except Europe model]  
 .....150 mV/3.2 k-ohms  
 [Europe model] .....150 mV/3.2 k-ohms

## GENERAL

Power Supply  
 [U.S.A. and Canada models]  
 .....AC 120V, 60 Hz  
 [Australia and U.K. models]  
 .....AC 240V, 50 Hz  
 [Europe model] .....AC 230V, 50 Hz  
 [General model]  
 .....AC 110/120/220/240V, 50/60 Hz

Power Consumption  
 [Canada model] .....270 VA, 250W  
 [U.S.A., Australia, U.K. and General  
 models] .....170W  
 [Europe model] .....130W

AC Outlets  
 2 SWITCHED OUTLETS  
 [Canada and Europe models]  
 .....100W max. total  
 [U.S.A. and General models]  
 .....200W max. total

1 SWITCHED OUTLET  
 [Australia and U.K. models]  
 .....100W max. total

Dimensions (W x H x D)  
 .....435 x 131 x 292 mm  
 (17-1/8" x 5-3/16" x 11-1/2")

Weight .....6.1 kg (13 lbs. 7 oz.)

Accessories .....AM loop antenna  
 Indoor FM antenna  
 Remote control transmitter  
 Batteries

Specifications are subject to change without notice.



# YAMAHA

---

YAMAHA ELECTRONICS CORPORATION, USA 6660 ORANGETHORPE AVE., BUENA PARK, CALIF. 90620, U.S.A.  
YAMAHA CANADA MUSIC LTD. 135 MILNER AVE., SCARBOROUGH, ONTARIO M1S 3R1, CANADA  
YAMAHA ELECTRONIK EUROPA G.m.b.H. SIEMENSSTR. 22-34, D-25462 RELLINGEN BEI HAMBURG, F.R. OF GERMANY  
YAMAHA ELECTRONIQUE FRANCE S.A. RUE AMBROISE CROIZAT BP70 CROISSY-BEAUBOURG 77312 MARNE-LA-VALLEE CEDEX02, FRANCE  
YAMAHA ELECTRONICS (UK) LTD. YAMAHA HOUSE, 200 RICKMANSWORTH ROAD WATFORD, HERTS WD1 7JS, ENGLAND  
YAMAHA SCANDINAVIA A.B. J A WETTERGRENS GATA 1, BOX 30053, 400 43 VÄSTRA FRÖLUNDA, SWEDEN  
YAMAHA MUSIC AUSTRALIA PTY, LTD. 17-33 MARKET ST., SOUTH MELBOURNE, 3205 VIC., AUSTRALIA

YAMAHA CORPORATION  
VN15630-1 BWWR,g Printed in Japan